

KOMATSU

RIDGWAY Rentals

PLANT RENTAL • HAULAGE • SALES • PARTS • SERVICE

PC210LCi-11

EU Stage IV Engine

intelligent
MACHINE CONTROL

HYDRAULIC EXCAVATOR



PC210LCi

ENGINE POWER

123 kW / 165 HP @ 2.000 rpm

OPERATING WEIGHT

22.120 - 23.580 kg

BUCKET CAPACITY

max. 1,68 m³

Walk-Around

PG210LGH-11



ENGINE POWER

123 kW / 165 HP @ 2.000 rpm

OPERATING WEIGHT

22.120 - 23.580 kg

BUCKET CAPACITY

max. 1,68 m³



EXCEPTIONAL WORKABILITY AND ENVIRONMENTAL PERFORMANCE

Powerful and Environmentally Friendly

- EU Stage IV engine
- Adjustable idle shutdown
- Komatsu fuel-saving technology

First-Class Comfort

- Fully air-suspended operator station
- Low-noise design
- Widescreen monitor

Intelligent Machine Control

- Innovative – Integrated – Intelligent
- Automatic real time digging control
- Drastically improved efficiency
- Intelligent touch screen monitor
- Factory installed components
- Komatsu auto tilt bucket

Safety First

- Komatsu SpaceCab™
- KomVision surround view system
- Neutral position detection system

Quality You Can Rely On

- Komatsu-quality components
- Extensive dealer support network

KOMTRAX

- Komatsu Wireless Monitoring System
- 3G mobile communications
- Integrated communication antenna
- Increased operational data and reports



A maintenance program for Komatsu customers

Intelligent Machine Control



Innovative

The PC210LCi-11 provides an outstanding improvement in productivity. It performs accurate rough digging, and completes final grade automatically, in just one pass. Cycle times and operator performance are improved, with a reduced risk of error and lower costs for fuel, labour and machine utilisation.

Greatly improved efficiency

Komatsu intelligent Machine Control lets you work quickly and easily, with no fear of over-digging. Efficiency and accuracy are greatly improved, as you can consistently achieve high bucket fills. With the “minimum distance” function, the PC210LCi-11 controls the bucket by automatically selecting the point on the bucket closest to the target surface. The surface is always protected.

Higher safety

Staking, surveying and final inspection were usually done manually. The PC210LCi-11 reduces or eliminates the need for this ground staff around the machine. GNSS antennae integrated in the handrails remove the need to access the top of the counterweight.



Komatsu/Lehnhoff auto tilt bucket

PC210LCi-11 has been developed for use with our new Auto Tilt Bucket. Using MS cylinder technology, auto stop control is enabled during tilting functions when used in semi-auto mode. Work efficiency and accuracy are enhanced.



Finger tip control

New lever functions allow the operator to raise or lower the design off-set at the touch of a button. Right lever trigger switch activates/deactivates semi-auto mode. Operator friendly and easy to use.



Automatic real time digging control

Komatsu intelligent Machine Control is based on Komatsu's unique sensor development, stroke sensing hydraulic cylinders and IMU sensor. You will no longer worry about over digging. When your bucket hits the target surface, the control function automatically limits and maintains grade with real-time bucket edge positioning.



Intelligent Machine Control

Integrated – Factory installed components

The intelligent Machine Control system is fully factory-integrated. Komatsu's unique stroke sensing cylinders for boom, arm, bucket and tilt bucket provide real time bucket tip positioning. Combined with built-in IMU sensor and GNSS antennae, the PC210LCi-11 can achieve incredibly accurate performance, consistently.

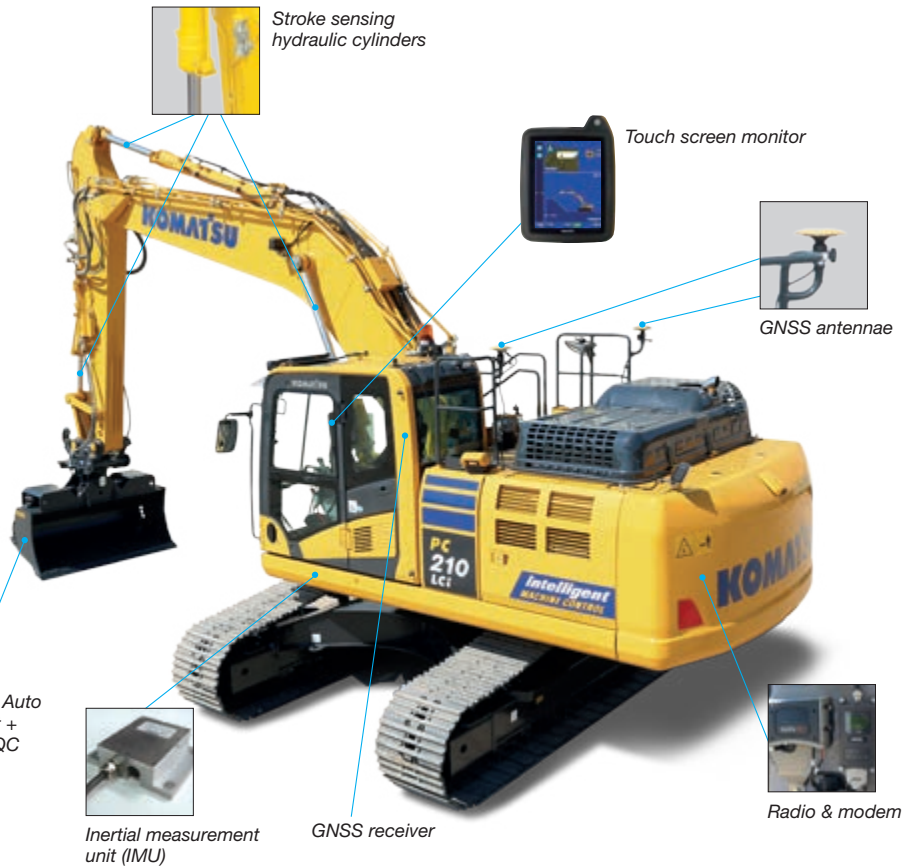

Factory-fit integrated Auto Tilt Bucket + Lehnhoff QC system

Factory-fit option of Lehnhoff HS-21 hydraulic quick coupler combined with Komatsu Auto Tilt Bucket. Developed with Lehnhoff, the new Auto Tilt Bucket incorporates stroke sensing cylinder technology to provide real time tilt positioning in semi-auto working.

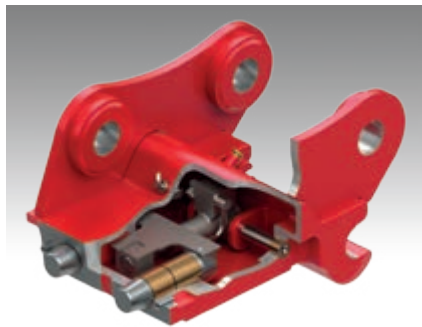

*HS-21 cut away
Proven quick coupler technology. Fully enclosed mechanism, twin tapered pins for consistent accurate locating. Integrated safety valve with constant pressurisation. Includes lifting hook with 10 t SWL.*



*Compact S shape
Round, compact shape for excellent fill values and easy discharge of material. Optional rear blade available. Reversible bolt on front cutting edge is standard on all ATB.*



Rear cutting edge available as option.



Lehnhoff bucket design with Komatsu MS cylinders

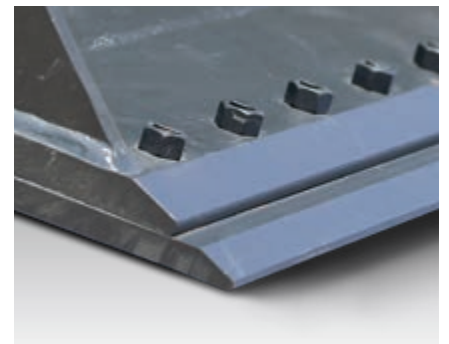

Reversible bolt on cutting edge

PC210LCi-11



Intelligent

The Komatsu PC210LCi-11 intelligent Machine Control excavator lets you focus on moving material efficiently, with no worry about digging too deep. Even with just the machine guidance function, operations are completed quicker thanks to the monitor's "real time" view, which offers high accuracy, shorter working hours and reduced costs for the job.



Intelligent touch screen monitor

The 12,1" touch screen monitor features accurate display of machine and design. Various split screen options give the operator the best possible information. The unique facing angle compass indicates the position of the bucket edge in relation to the slope. Gradual adjustment of the tilt bucket allows the operator to create complex design surfaces while in semi-auto.

Powerful and Environmentally Friendly



Higher productivity

The PC210LCi-11 is quick and precise. It features a powerful Komatsu EU Stage IV engine, Komatsu's Closed Center Load Sensing (CLSS) hydraulic system and first-class Komatsu comfort to provide a fast response and unrivalled productivity for its class.

Komatsu fuel-saving technology

Fuel consumption on the PC210LCi-11 is lower by up to 6%. Engine management is enhanced. The variable speed matching of the engine and hydraulic pumps and a viscous fan clutch guarantee efficiency and precision during single and combined movements.

Adjustable idle shutdown

The Komatsu auto idle shutdown automatically turns off the engine after it idles for a set period of time. This feature can easily be programmed from 5 to 60 minutes, to reduce unnecessary fuel consumption and exhaust emissions, and to lower operating costs. An Eco-gauge and the Eco guidance tips on the cab monitor further encourage efficient operations.

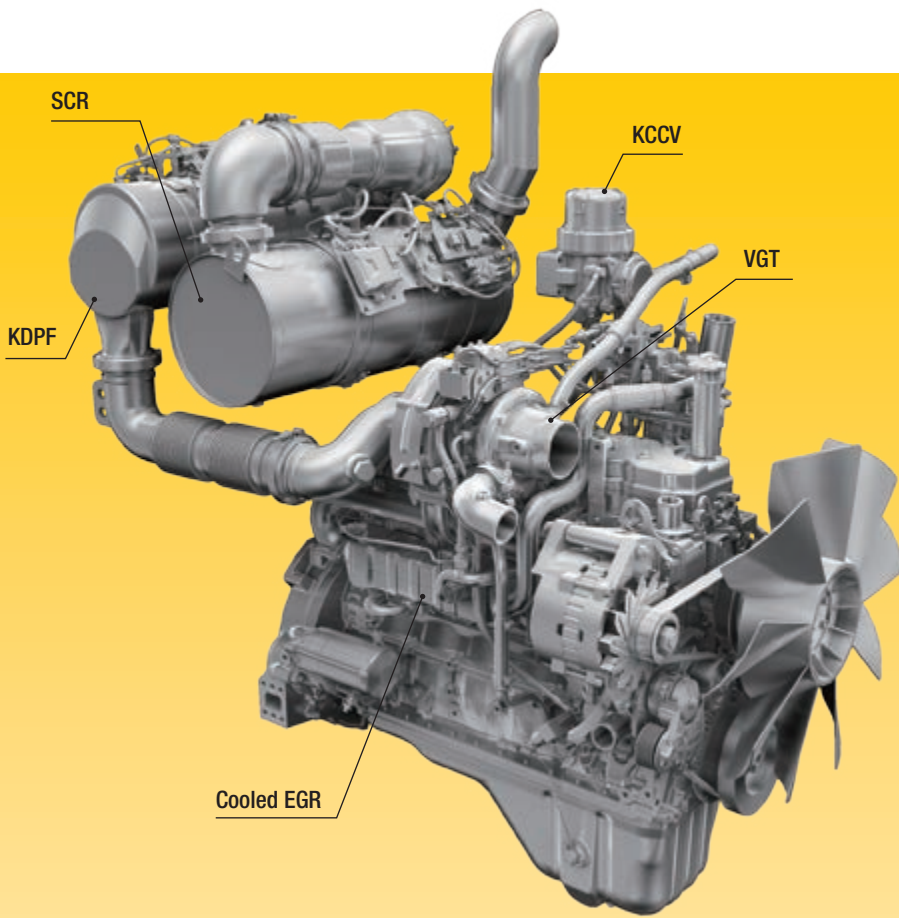

Komatsu EU Stage IV

The Komatsu EU Stage IV engine is productive, dependable and efficient. With ultra-low emissions, it provides a lower environmental impact and a superior performance to help reduce operating costs and lets the operator work in complete peace of mind.

Heavy-duty aftertreatment

The aftertreatment system combines a Komatsu Diesel Particulate Filter (KDPF) and Selective Catalytic Reduction (SCR). The SCR injects the correct amount of AdBlue® into the system at the proper rate to break down NOx into water (H₂O) and non-toxic nitrogen gas (N₂). NOx emissions are reduced by 80% vs. EU Stage IIIB engines.

Exhaust Gas Recirculation (EGR)

Cooled EGR is a technology well-proven in current Komatsu engines. The increased capacity of the EGR cooler now ensures very low NOx emissions and a better engine performance.

Komatsu Closed Crankcase Ventilation (KCCV)

Crankcase emissions (blow-by gas) are passed through a CCV filter. The oil mist trapped in the filter is returned back to the crankcase while the filtered gas is returned to the air intake.

High-Pressure Common Rail (HPCR)

To achieve complete fuel burn and lower exhaust emissions, the heavy-duty High-Pressure Common Rail fuel injection system is computer controlled to deliver a precise quantity of pressurised fuel into the redesigned engine combustion chamber by multiple injections.

Variable Geometry Turbo (VGT)

The VGT provides optimal airflow to the engine combustion chamber under all speed and load conditions. Exhaust gas is cleaner, fuel economy is improved while machine power and performance are maintained.

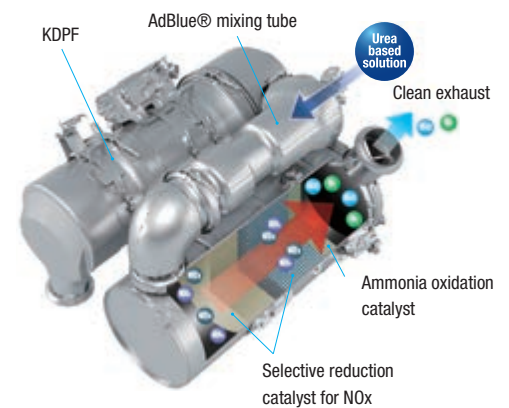

Eco-gauge, Eco guidance and fuel consumption gauge



ECO guidance record

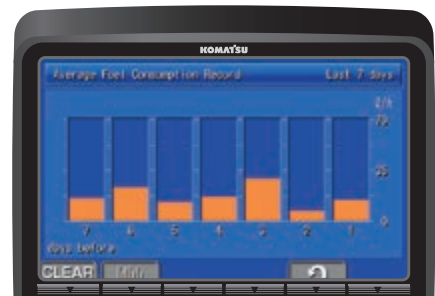

Fuel consumption history

First-Class Comfort

Increased comfort

In the wide Komatsu SpaceCab™, a standard air-suspended high-back seat, heated for improved comfort and with fully adjustable armrests, is the centre of a comfortable and low-fatigue working environment. High visibility and ergonomic controls further assist to maximise the operator's productivity.

Perfect operator convenience

In addition to the standard radio, the PC210LCi-11 has an auxiliary input for connecting external devices and play music through the cab speakers. Two 12-volt power ports are also incorporated in the cab. Proportional controls are fitted as standard for safe and precise operation of attachments.

Low-noise design

Komatsu crawler excavators have very low external noise levels and are especially well-suited for work in confined spaces or urban areas. The optimal usage of sound insulation and of sound absorbing materials helps to make noise levels inside the cab comparable to those of an executive car.



Convenient, ergonomic and precise control: joysticks with proportional control button for attachments



Plenty of storage room, a hot and cool box, a magazine box and a cup holder



Armrest with simple height adjustment

Information & Communication Technology



Lower operating costs

Komatsu ICT contributes to the reduction of operating costs by assisting to comfortably and efficiently manage operations. It raises the level of customer satisfaction and the competitive edge of our products.

Widescreen monitor

Installed with a choice of 26 languages, the widescreen monitor with simple switches and multifunction keys gives fingertip access to a large range of functions and operating info.

An evolutionary interface

Helpful information is now easier than ever to find and understand with the upgraded monitor interface. An optimal main screen for the ongoing work can be selected simply by pressing the F3 key.



Three pre-set flow selections for Auto Tilt Bucket. Precise finger tip control



With KomVision, various camera view options are available whilst maintaining constant "birdview" from above the machine

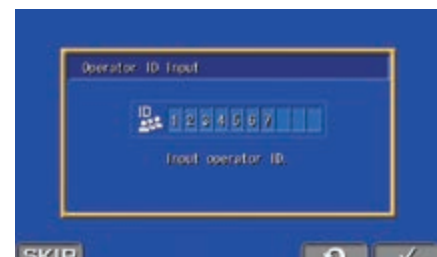

Operator identification function

Safety First

PC210LCI-11



Optimal jobsite safety

Safety features on the Komatsu PC210LCi-11 comply with the latest industry standards and work in synergy to minimise risks to people in and around the machine. A neutral detection system for travel and work equipment levers increase jobsite safety, along with a seat belt caution indicator and an audible travel alarm. Highly durable anti-slip plates – with additional high friction covering – maintain long term traction performance.



Side-view cameras



Exceptional operator protection



Hand rails and anti-slip plates

KomVision

KomVision machine visibility gives the operator a constant clear view of the safety zone around the machine. This allows the operator to focus on the work at hand even in low light conditions.

Komatsu SpaceCab™

The ROPS cab has a tubular steel frame and provides high shock absorbency, impact resistance and durability. The seat belt is well designed to keep the operator in the safety zone of the cab in the event of a rollover. Optionally the cab can be fitted with a Falling Object Protective System (FOPS) with openable front guard.

Safe maintenance

Thermal guards around high temperature areas of the engine, protected fan belt and pulleys, a pump/engine partition that prevents hydraulic oil from spraying onto the engine, and exceptionally sturdy handrails: in Komatsu tradition, the highest safety level is provided for a fast and smooth maintenance.

Quality You Can Rely On

Komatsu-quality

With the latest computer techniques and a thorough test programme, Komatsu produces equipment to meet your highest standards. All major components of the PC210LCi-11 are designed and directly manufactured by Komatsu, and essential machine functions are perfectly matched for a highly reliable and productive excavator. Each and every PC210LCi-11 undergoes additional system calibration and accuracy tests before delivery, to ensure optimum performance in line with strict Komatsu Engineering Standards.

Rugged design

Maximum toughness and durability are the cornerstones of Komatsu's philosophy – along with safety and top class customer service. Single piece plates and castings are used in key areas of the machine's structure for good load distribution. Highly durable rubbing strips on the underside of the arm protect the structure against impact damage.

Extensive support network

The extensive Komatsu distribution and dealer network is standing by to help keep your fleet in optimum condition. Customised servicing packages are available, with express availability of spare parts, to make sure that your Komatsu equipment continues to perform at its peak. Highly trained and dedicated Technical Support Engineers are always available to ensure intelligent Machine Control performance is maintained.

Underwater operation

All sensor connections are IP69 rated to allow semi-auto working under water. Perfect for river & canal cleaning.



Quick release waterproof electrical connections are protected by strong flip down cover



Easy Maintenance



Central service points

Komatsu designed the PC210LCi-11 with centralised and conveniently located service points to make necessary inspections and maintenance quick and easy.

Komatsu CARE™

Komatsu CARE™ is a maintenance program that comes as standard with your new Komatsu machine. It covers factory-scheduled maintenance, performed with Komatsu Genuine parts by Komatsu-trained technicians. Depending on your machine's engine, it also offers extended coverage of the Komatsu Diesel Particulate Filter (KDPF) or the Komatsu Diesel Oxidation Catalyst (KDOC), and of the Selective Catalytic Reduction (SCR). Please contact your local Komatsu distributor for terms and conditions.



Long-life oil filters

The Komatsu Genuine hydraulic oil filter uses high-performance filtering material for long replacement intervals, which significantly reduces maintenance costs.



AdBlue® tank

For simple access, the AdBlue® tank is installed on the front stairway.

Flexible warranty

When you purchase Komatsu equipment, you gain access to a broad range of programmes and services that have been designed to help you get the most from your investment. For example, Komatsu's Flexible Warranty Programme provides a range of extended warranty options on the machine and its components. These can be chosen to meet your individual needs and activities. This programme is designed to help reduce total operating costs.

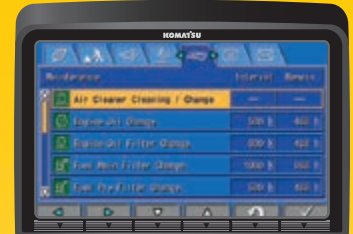

Basic maintenance screen

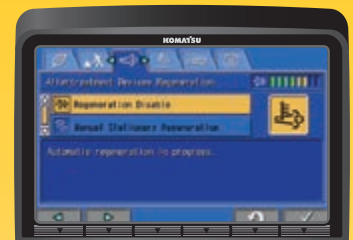

Aftertreatment device regeneration screen for the KDPF



AdBlue® level and refill guidance



Easy access to reset MC-R3 receiver



KOMTRAX

The way to higher productivity

KOMTRAX uses the latest wireless monitoring technology. Compatible on PC, smartphone or tablet, it delivers insightful and cost saving information about your fleet and equipment, and offers a wealth of information to facilitate peak machine performance. By creating a tightly integrated web of support it allows proactive and preventive maintenance and helps to efficiently run a business.



Knowledge

You get quick answers to basic and critical questions about your machines – what they're doing, when they did it, where they're located, how they can be used more efficiently and when they need to be serviced. Performance data is relayed by wireless communication technology (satellite, GPRS or 3G depending on model) from the machine to a computer and to the local Komatsu distributor – who's readily available for expert analysis and feedback. Additional reports are generated to monitor intelligent Machine Control usage.



Power

The detailed information that KOMTRAX puts at your fingertips 24 hours a day, 7 days a week gives the power to make better daily and long-term strategic decisions – at no extra cost. Problems can be anticipated, maintenance schedules customised, downtime minimised and machines kept where they belong: working on the jobsite.

Convenience

KOMTRAX enables convenient fleet management on the web, wherever you are. Data is analysed and packaged specifically for effortless and intuitive viewing in maps, lists, graphs and charts. You can foresee eventual maintenance issues and required spare parts, and troubleshoot a problem before Komatsu technicians arrive on site.

Specifications

ENGINE

Model	Komatsu SAA6D107E-3
Type	Common rail direct injection, water-cooled, emissionised, turbocharged, after-cooled diesel
Engine power	
at rated engine speed	2.000 rpm
ISO 14396	123 kW / 165 HP
ISO 9249 (net engine power)	118 kW / 158 HP
No. of cylinders	6
Bore x stroke	107 x 124 mm
Displacement	6,69 l
Air filter type	Double element type with monitor panel dust indicator and auto dust evacuator
Cooling	Suction type cooling fan with radiator fly screen

HYDRAULIC SYSTEM

Type	HydrauMind. Closed-centre system with load sensing and pressure compensation valves
Additional circuits	2 additional circuits with proportional control can be installed
Main pump	2 variable displacement piston pumps supplying boom, arm, bucket, swing and travel circuits
Maximum pump flow	475 l/min
Relief valve settings	
Implement	380 kg/cm ²
Travel	380 kg/cm ²
Swing	295 kg/cm ²
Pilot circuit	33 kg/cm ²

SERVICE REFILL CAPACITIES

Fuel tank	400 l
Radiator	30,7 l
Engine oil	23,1 l
Swing drive	6,5 l
Hydraulic tank	132 l
Final drive (each side)	5,0 l
AdBlue® tank	23,1 l

OPERATING WEIGHT (APPR.)

MONO BOOM		
Triple grouser shoes	Operating weight	Ground pressure
600 mm	22.410 kg	0,47 kg/cm ²
700 mm	22.690 kg	0,41 kg/cm ²
800 mm	23.010 kg	0,36 kg/cm ²
900 mm	23.340 kg	0,33 kg/cm ²

Operating weight, including specified work equipment, mono boom, 2,9 m arm, 0,8 m³ bucket, operator, lubricant, coolant, full fuel tank and the standard equipment.

SWING SYSTEM

Type	Axial piston motor driving through planetary double reduction gearbox
Swing lock	Electrically actuated wet multidisc brake integrated into swing motor
Swing speed	0 - 12,4 rpm
Swing torque	65 kNm

DRIVES AND BRAKES

Steering control	2 levers with pedals giving full independent control of each track
Drive method	Hydrostatic
Travel operation	Automatic 3-speed selection
Gradeability	70%, 35°
Max. travel speeds	
Lo / Mi / Hi	3,0 / 4,1 / 5,5 km/h
Maximum drawbar pull	20.600 kg
Brake system	Hydraulically operated discs in each travel motor

UNDERCARRIAGE

Construction	X-frame centre section with box section track frames
Track assembly	
Type	Fully sealed
Shoes (each side)	49
Tension	Combined spring and hydraulic unit
Rollers	
Track rollers (each side)	9
Carrier rollers (each side)	2

ENVIRONMENT

Engine emissions	Fully complies with EU Stage IV exhaust emission regulations
Noise levels	
LwA external	100 dB(A) (2000/14/EC Stage II)
LpA operator ear	67 dB(A) (ISO 6396 dynamic test)
Vibration levels (EN 12096:1997)	
Hand/arm	≤ 2,5 m/s ² (uncertainty K = 0,49 m/s ²)
Body	≤ 0,5 m/s ² (uncertainty K = 0,24 m/s ²)
Contains fluorinated greenhouse gas HFC-134a (GWP 1430). Quantity of gas 0,9 kg; CO ₂ equivalent 1,29 t	

Dimensions & Performance Figures

MACHINE DIMENSIONS

A	Overall width of upper structure	2.850 mm
B	Overall height (top of cab)	3.045 mm
	Overall height (handrail)	3.135 mm
C	Overall length of basic machine	5.135 mm
D	Tail length	2.910 mm
	Tail swing radius	2.940 mm
E	Clearance under counterweight	1.085 mm
F	Machine tail height	2.250 mm
G	Ground clearance	440 mm
H	Tumbler centre distance	3.655 mm
I	Track length	4.450 mm
J	Track gauge	2.380 mm
K	Track shoe width	600, 700, 800, 900 mm
L	Overall track width with 600 mm shoes	2.980 mm
	Overall track width with 700 mm shoes	3.080 mm
	Overall track width with 800 mm shoes	3.180 mm
	Overall track width with 900 mm shoes	3.280 mm

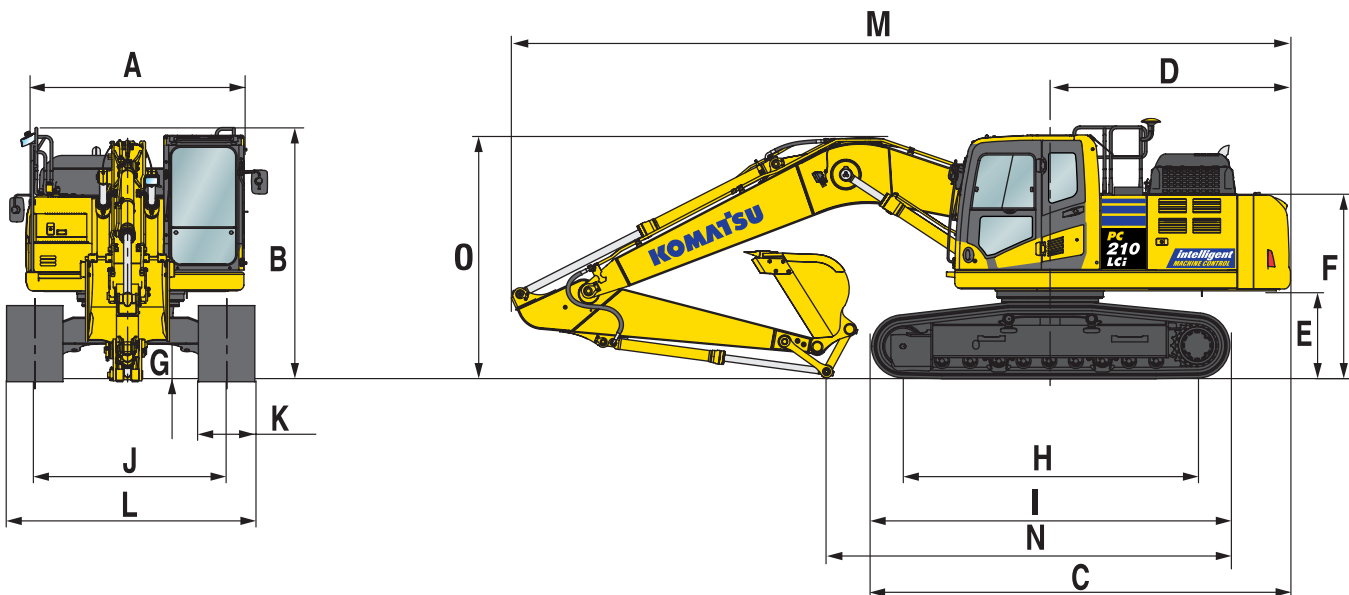

TRANSPORT DIMENSIONS

	Arm length	2,9 m
M	Transport length	9.625 mm
N	Length on ground (transport)	5.000 mm
O	Overall height (to top of boom)	2.995 mm

Dimensions & Performance Figures

MAX. BUCKET CAPACITY AND WEIGHT

	MONO BOOM	
Arm length	2,9 m	
Material weight up to 1,2 t/m ³	1,65 m ³	1.150 kg
Material weight up to 1,5 t/m ³	1,40 m ³	1.025 kg
Material weight up to 1,8 t/m ³	1,22 m ³	925 kg

Max. capacity and weight have been calculated according to ISO 10567:2007.

Please consult with your distributor for the correct selection of buckets and attachments to suit the application.

BUCKET AND ARM FORCE

Arm length	2,9 m
Bucket digging force	14.100 kg
Bucket digging force at PowerMax	15.200 kg
Arm crowd force	10.300 kg
Arm crowd force at PowerMax	11.000 kg

WORKING RANGE

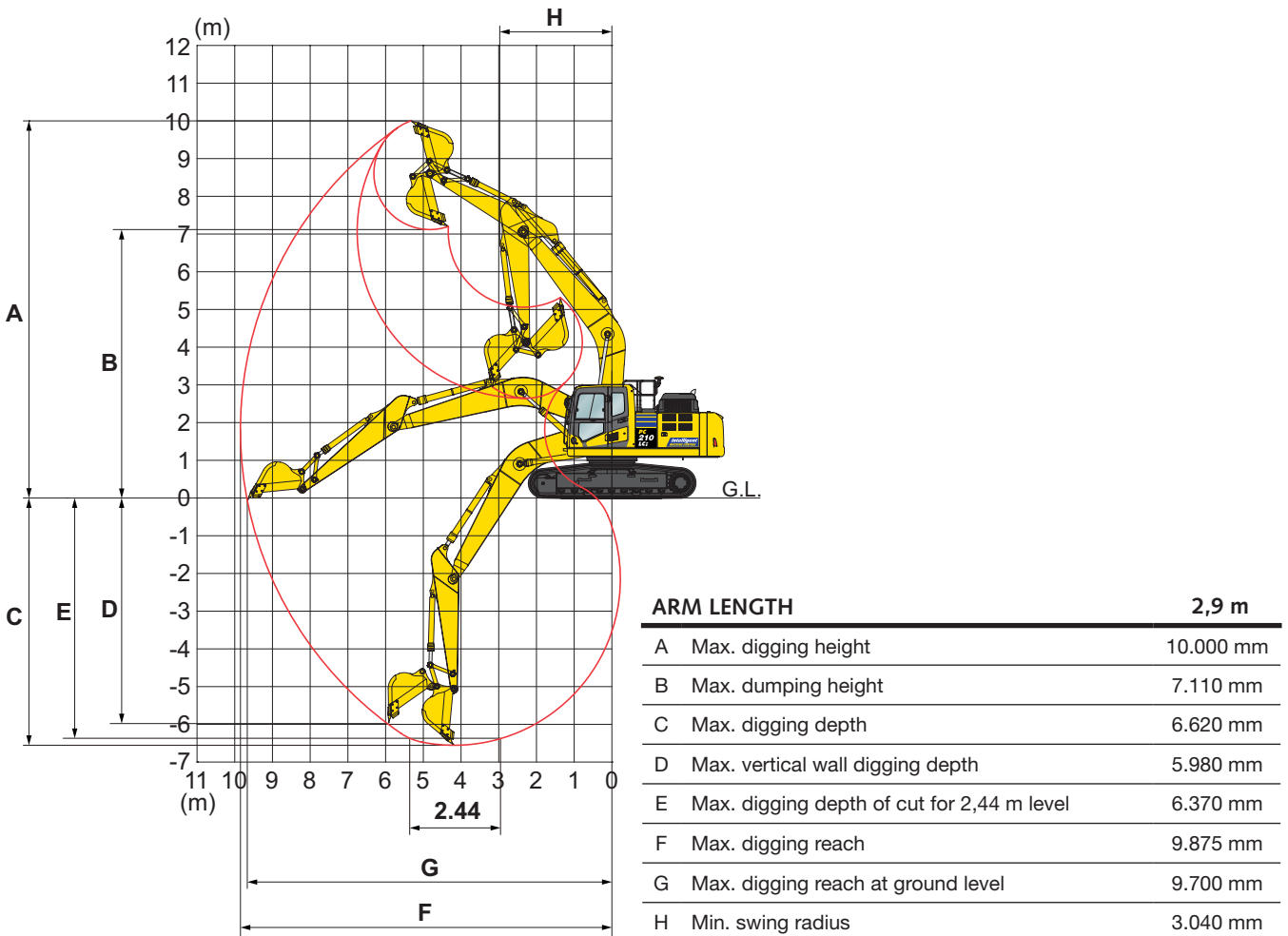

Lifting Capacity

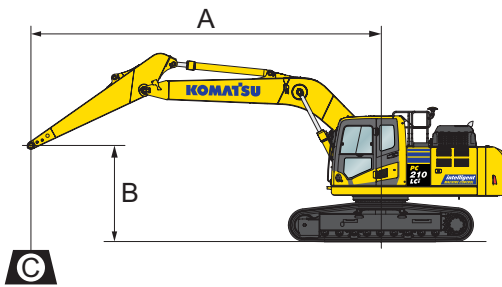

- A – Reach from swing center
- B – Bucket hook height
- C – Lifting capacities

Weights:
 With 2,9 m arm: bucket linkage and bucket cylinder: 335 kg
 With 600 mm shoes

- Rating over front
- Rating over side
- Rating at maximum reach

Arm length	A		7,5 m		6,0 m		4,5 m		3,0 m		1,5 m	
	B											

	7,5 m kg	*4.060	*4.060										
	6,0 m kg	*3.820	*3.820										
	4,5 m kg	*3.800	3.700	*5.770	4.050	*7.210	5.670						
	3,0 m kg	*3.930	3.400	5.890	3.940	8.260	5.430	*10.510	8.180				
	1,5 m kg	*4.210	3.290	5.760	3.820	7.980	5.180	12.560	7.660				
	0,0 m kg	*4.720	3.350	5.650	3.730	7.780	5.000	12.210	7.370	*7.200	*7.200		
	-1,5 m kg	5.480	3.620	5.620	3.700	7.690	4.920	12.100	7.280	*11.680	*11.680	*7.480	*7.480
	-3,0 m kg	6.520	4.250			7.730	4.950	12.170	7.340	*17.930	14.040	*12.100	*12.100
	-4,5 m kg	*8.800	5.940							*10.890	7.560	*15.170	14.430

* Load is limited by hydraulic capacity rather than tipping.

Ratings are based on SAE Standard No. J1097.

Rated loads do not exceed 87% of hydraulic lift capacity or 75% of tipping load.

When lifting with additional equipment installed to the arm, please subtract the weight of all additional equipment from the values stated.

AUTO TILT BUCKET OPTIONS

Factory fit options (Fitted, calibrated ready for work)

Bucket width	Capacity (SAE)	Bucket weight	Rear back blade	Direct mount	QC Lehnhoff HS21
1.800 mm	0,68 m ³	800 kg	○	○	○
2.000 mm	0,86 m ³	900 kg	○	○	○
2.200 mm	1,04 m ³	1.000 kg	○	○	○

Lehnhoff supplied individual options also available

Standard and Optional Equipment

ENGINE

Komatsu SAA6D107E-3 turbocharged common rail direct injection diesel engine	●
EU Stage IV compliant	●
Suction type cooling fan with radiator fly screen	●
Automatic engine warm-up system	●
Engine overheat prevention system	●
Fuel control dial	●
Auto-deceleration function	●
Adjustable idle shutdown	●
Engine key stop	●
Engine ignition can be password secured on request	●
Alternator 24 V / 90 A	●
Starter motor 24 V / 5,5 kW	●
Batteries 2 × 12 V / 180 Ah	●

INTELLIGENT MACHINE CONTROL

Standard factory installed integrated 3D GNSS intelligent Machine Control system	●
Automatic bucket control	●

HYDRAULIC SYSTEM

Electronic closed-centre load sensing (E-CLSS) hydraulic system (HydrauMind)	●
Pump and engine mutual control (PEMC) system	●
6-working mode selection system; Power mode, Economy mode, Breaker mode, Attachment Power and Attachment Economy mode, and Lifting/Fine Operation mode	●
PowerMax function	●
Adjustable PPC wrist control levers for arm, boom, bucket and swing, with sliding proportional control for attachments and auxiliary buttons	●
Prepared for hydraulic quick-coupler	●
Additional hydraulic functions	○

UNDERCARRIAGE

Track roller guards	●
Track frame under-guards	●
600, 700, 800, 900 mm triple grouser shoes	○
Full length track roller guards	○

CABIN

Reinforced safety SpaceCab™; highly pressurised and tightly sealed hyper viscous mounted cab with tinted safety glass windows, large roof window with sun shade, pull-up type front window with locking device, removable lower window, front window wiper with intermittent feature, sun roller blind, cigarette lighter, ashtray, luggage shelf, floor mat	●
Heated, high-back air-suspended seat with lumbar support, console mounted height adjustable arm rests, and retractable seat belt	●
Automatic climate control system	●
12 / 24 Volt power supplies	●
Beverage holder and magazine rack	●
Hot and cool box	●
Radio	●
Auxiliary input (MP3 jack)	●
Lower wiper	○
Rain visor (not with OPG)	○

SERVICE AND MAINTENANCE

Automatic fuel line de-aeration	●
Double element type air cleaner with dust indicator and auto dust evacuator	●
KOMTRAX – Komatsu wireless monitoring system (3G)	●
Komatsu CARE™ – a maintenance program for Komatsu customers	●
Multifunction video compatible colour monitor with Equipment Management and Monitoring System (EMMS) and efficiency guidance	●
Toolkit	●
Service points	○
Automatic greasing system	○

WORK EQUIPMENT

Mono boom	●
2,9 m arm	●
Auto tilt bucket preparation including quick release electrical connection on arm	●
Bucket linkage with lifting eye	○
Komatsu buckets	○
Komatsu auto tilt bucket	○
Komatsu breakers	○
Lehnhoff HS-21 quick coupler	○

SAFETY EQUIPMENT

KomVision surround view system	●
Electric horn	●
Overload warning device	●
Audible travel alarm	●
Boom safety valves	●
Large handrails, rear-view mirrors	●
Battery main switch	●
ROPS compliant to ISO 12117-2:2008	●
Emergency engine stop switch	●
Seat belt caution indicator	●
Neutral position detection system	●
Arm safety valve	●
OPG Level II front guard (FOPS), hinged type	○
OPG Level II top guard (FOPS)	○

DRIVES AND BRAKES

Hydrostatic, 3-speed travel system with automatic shift and planetary gear type final drives, and hydraulic travel and parking brakes	●
PPC control levers and pedals for steering and travel	●

LIGHTING SYSTEM

Working lights: 2 revolving frame, 1 boom (l.h.)	●
Additional working lights: 4 cab roof (front), 1 cab roof (rear), 1 boom (r.h.), 1 counterweight (rear), beacon	○

OTHER EQUIPMENT

Standard counterweight	●
Remote greasing for swing circle and pins	●
Electric refuelling pump with automatic shut-off function	●
Biodegradable oil for hydraulic system	○
Customised paint	○

Further equipment on request

- standard equipment
- optional equipment

Your Komatsu partner:

KOMATSU

Komatsu Europe International N.V.
 Mechelsesteenweg 586
 B-1800 VILVOORDE (BELGIUM)
 Tel. +32-2-255 24 11
 Fax +32-2-252 19 81
www.komatsu.eu

UENSS18500 08/2017

KOMATSU is a trademark of Komatsu Ltd. Japan.