

NEW

JSI30 | HYDRAULIC EXCAVATOR



Hydraulic Excavator JSI30 LC

Engine Power: 81kW (109hp) Bucket Capacity: 0.34 – 0.85m³ Operating weight: 13,183 – 13,762kg



WHY COMPROMISE?

JCB's new JS130 LC is designed to offer performance and productivity without compromise. This new machine has been designed and developed using our 48 years of excavator expertise and, crucially, our Efficient Design philosophy.

As a result, the new JS130 is equipped with a host of performance, comfort, safety and efficiency innovations, including our new award-winning super-efficient EcoMAX T4i engine. Uniquely, EcoMAX meets Stage IIIB/Tier 4i legislation without the need for bulky DPF or SCR.

Because installation is therefore compact, you can enjoy uncompromised visibility. And because maintenance is more straightforward, you can enjoy lower running costs too.

In short, any excavator other than a JCB is simply a compromise.

DYNAMIC LIVELINK TELEMATICS SYSTEM

NO ADDITIONAL AFTERTREATMENT

**LARGE ATTACHMENTS AND OPTIONS
RANGE FOR VERSATILITY**



A yellow JCB tracked loader is shown from a front-three-quarter perspective. The machine is semi-transparent, revealing internal components like the engine and hydraulic systems. The background is a dark green gradient with light rays emanating from the machine. The JCB logo is visible on the side of the engine compartment.

UNHINDERED VISIBILITY

UP TO 10% FUEL SAVING
SAVE £1,918* IN FUEL OVER 3 YEARS

JCB SMART CONTROLLER

**LOW-EMISSION ECOMAX
T4i ENGINE**

JCB "2GO" IMPROVES SAFETY

*Figures quoted based on tests of the new T4i JS130 vs outgoing model, calculated on 3,600 hours over 3 years, 72p per litre, JCB's mixed duty cycle. The data and potential fuel efficiency savings are based on JCB research figures. The figures are only intended to give an indication of potential saving and should not be taken as actual savings. JCB reserve the right to change and amend data.

Strength
inside and out



Boom and dipper

- Reinforced boom
- Endurance testing
- Precision engineering

Componentry

- Best components in the industry
- Brand new state-of-the-art Stage 3B/Tier 4i-compliant EcoMAX engine.

Structural strength

- High-strength undercarriage
- Rigid upper frame
- Stiff, durable door design

BEFORE YOU BUY AN EXCAVATOR, YOU NEED TO KNOW IT'S GOING TO BE TOUGH ENOUGH TO PERFORM ANY JOB YOU ASK OF IT. FORTUNATELY, WITH A JCB JSI30LC, STRENGTH AND DURABILITY COME AS STANDARD.



1

Boom and dipper

1 A JCB JSI30LC's reinforced boom and dipper is made of high tensile strength steel, with single piece wrapper plates and internal baffle plates for long life durability.

2 Our advanced manufacturing and assembly processes produce high precision and quality assembled components.

Componentry

3 Our engine technology is tried and proven; we've built 200,000 DIESELMAX units since 2004. To ensure similar longevity, the JSI 30's EcoMAX T4i/Stage 3B engine has been tested for 110,000 hours in 70 different machines across the toughest applications and environments.

4 JCB JSI 30s boast the best components in the industry, including Berco running gear, Kawasaki pumps, Kayaba valve blocks and JCB EcoMAX engines.



2

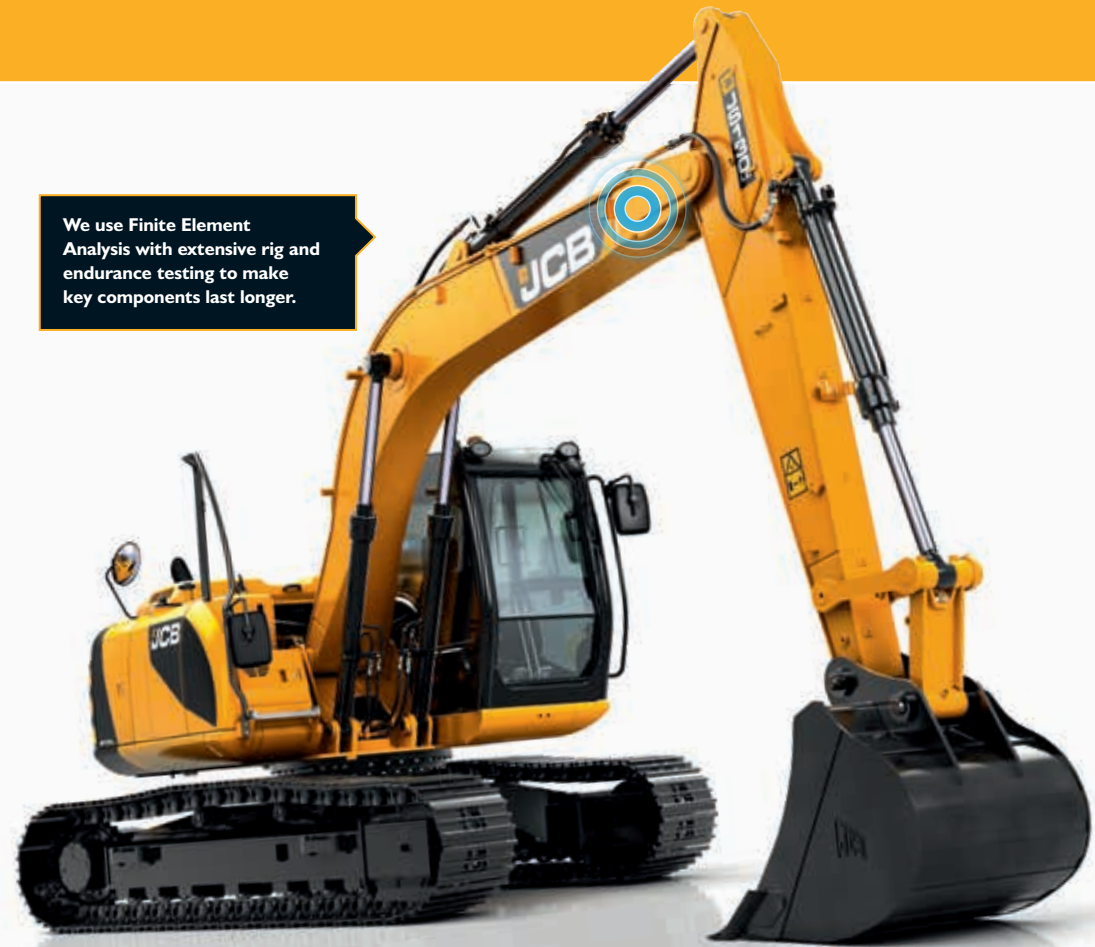

We use Finite Element Analysis with extensive rig and endurance testing to make key components last longer.



3



4



Structural strength

- 4 The high-strength undercarriage of a JCB JS130 LC uses a fully-welded X frame construction for long-term durability even in the most demanding applications.
- 5 A closed box section revolving frame increases strength and reduces stress. It's also highly resistant to impact damage.
- 6 The 130's high-strength rigid upper frame provides maximum durability and support.
- 7 Our stiff, durable door design gives great strength and rigidity.

UNEARTHED: KEY FACT

The JCB JS130 turret is welded to both the upper and lower undercarriage frame.



4

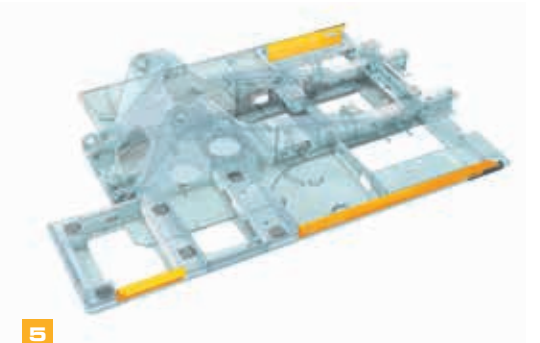

5



7



6

maximum
productivity,
minimum spend



Upping output

Intuitive multifunction operation

Hydraulic regeneration system

Cushioned boom and dipper ends

The efficient excavator

Advanced hydraulic technology

EcoMAX engine produces high power and torque at low revs

Variable power bands

Versed in versatility

Wide attachments range

JCB quickhitch system

Dozer blade and street pad options

SAVING MONEY AND TIME IS MORE IMPORTANT THAN EVER, SO WE'VE MADE SURE THE NEW JCB JS130 LC'S COMPONENTRY – INCLUDING THE ECOMAX T4i ENGINE – WORKS IN PERFECT HARMONY. IN TURN, YOU GET A MACHINE THAT'S AS EFFICIENT AND PRODUCTIVE AS POSSIBLE.

Versed in versatility

1 JCB's quickhitch system makes attachment changing fast and easy, and is purpose-designed for the JS range.

For ultra versatility, JCB offers a full list of auxiliary pipework options including hammer, auxiliary, and low flow.

2 An optional dozer blade increases versatility for grading.

Choose the optional rubber street pads and you can use the JS130 on sensitive grounds like tarmac without causing damage.

3 A relatively low operating weight of 13.5T means the JS130 can be towed on a 6-wheel lorry*, making it portable for plant hire and inner city/urban applications.

* Territory dependant



The JS130 LC is a hugely versatile machine that's made all the more so by a big range of attachments, enabling you to carry out a wide range of tasks.

Upping output

- 4 Simultaneous tracking and excavating is smooth and fast with an intuitive multifunction operation.
- 5 A JCB JSI 30 has a solid, stable work platform for fast cycle times.
- 6 With a massive 92kN bucket tearout and fast cycle times, the JSI 30 is extremely productive in all applications.
- 7 JCB's innovative hydraulic regeneration system means oil is recycled across the cylinders for faster cycle times and reduced fuel consumption.

The efficient excavator

- 8 JCB's new EcoMAX T4i/Stage3B engine uses up to 10% less fuel than our Tier 3 units, saving you money. This is partly due to the fact that EcoMAX produces high torque at just 1500 - 1600 rpm, making for improved fuel-efficient matching of the hydraulics.
- 9 To reduce noise pollution from unnecessary air flow, the JSI 30's engine-driven cooling fan has a proportional control system, maintaining optimum fan speed.
- 10 The JSI 30's variable power bands allow you to tailor performance – and therefore economy – to specific tasks.



To save fuel, JCB Auto-Idle technology automatically reduces engine speed when hydraulics aren't in use. To optimise fuel efficiency still further, the JSI 30 benefits from advanced hydraulic technology, including optimised hydraulic pump settings, advanced spool design, and cutting edge electronic management software.

UNEARTHED: KEY FACT
A JCB JSI 30 has cushioned boom and dipper ends to prevent shock loadings, protect your machine and increase operator comfort.

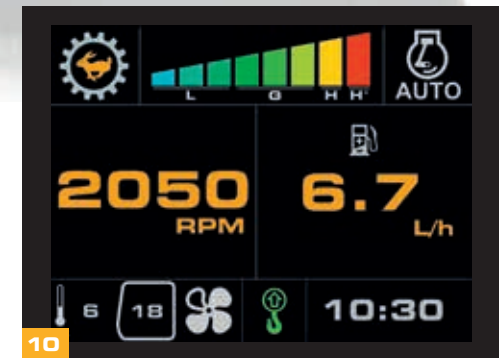

a comfortable
favourite



Comfortably in control

- Smooth, intuitive, adjustable controls
- Balanced slew
- Ergonomic switches
- Optional proportional controls

Visibly better

- 70/30 front screen split
- Laminated glass roof
- Innovative low-level bonnet

The working environment

- Low noise and vibration levels
- Spacious working area and storage

JCB EXCAVATORS ARE DESIGNED AROUND THE OPERATOR. THAT'S GOOD FOR THEM BUT EVEN BETTER FOR YOU; AFTER ALL, GREAT COMFORT AND EASE OF USE EQUALS GREAT PRODUCTIVITY.

Visibly better

- 1 A 70/30 front screen split gives JCB JS130s excellent front visibility. A clear view of the front right track provides easy, safe trench digging and manoeuvring.
- 2 An innovative low-level bonnet provides excellent rearward visibility.

Comfortably in control

- 3 The 4" colour multi-function display is easy to read in all light conditions, provides instant operational information, and has a customisable home screen.

The JS130's Tool Select feature can set up auxiliary hydraulic circuits quickly and accurately to match flow and pressure requirements of any attachment.



A large laminated glass roof window gives the JS130 optimum visibility for working at height.

Light, intuitive and smooth controls improve comfort and productivity. The JS130's joystick-mounted power boost button gives extra hydraulic power fast.

A balanced slew and electronic/hydraulic controlled slew braking give speed and precision.



The JS130's cab and controls are independently adjustable so that it's easy to find the perfect operating position.



We offer tailored seating options to suit many different applications.

The working environment

e The JS130 creates a quieter working environment inside and out. Because we've reduced noise levels to 70dB(A) inside and 99dB(A) outside, you can use the machine at any location, any time. JCB JS130 cabs use 6 viscous rubber mounts to minimise noise and vibration.

The positive pressure cab keeps out dirt and dust.

7 JCB's climate control option offers a precisely controlled cab temperature with fresh or recirculated air. Demisting/defrosting functions keep a JS130's front window clear.

e There's a spacious luggage tray behind the operator's seat.

e A large floor area with large high grip pedals gives easy and precise tracking.



7



8



9



**less servicing,
more.
service**

Here to help

In-cab system monitoring

The best back-up in the business

Easy access grease points

Large service bays

Radiator, cooler and intercooler easily accessed



Easy does it

1000-hour boom and dipper servicing intervals

5000-hour hydraulic oil life

Easily-accessible filters

WE'VE DESIGNED THE JCB JSI30LC TO BE LOW MAINTENANCE AND EASILY SERVICEABLE. THIS MAKES IT AFFORDABLE, EFFICIENT AND HIGHLY PRODUCTIVE, HELPING YOU GET THE BEST SERVICE FROM YOUR MACHINE.

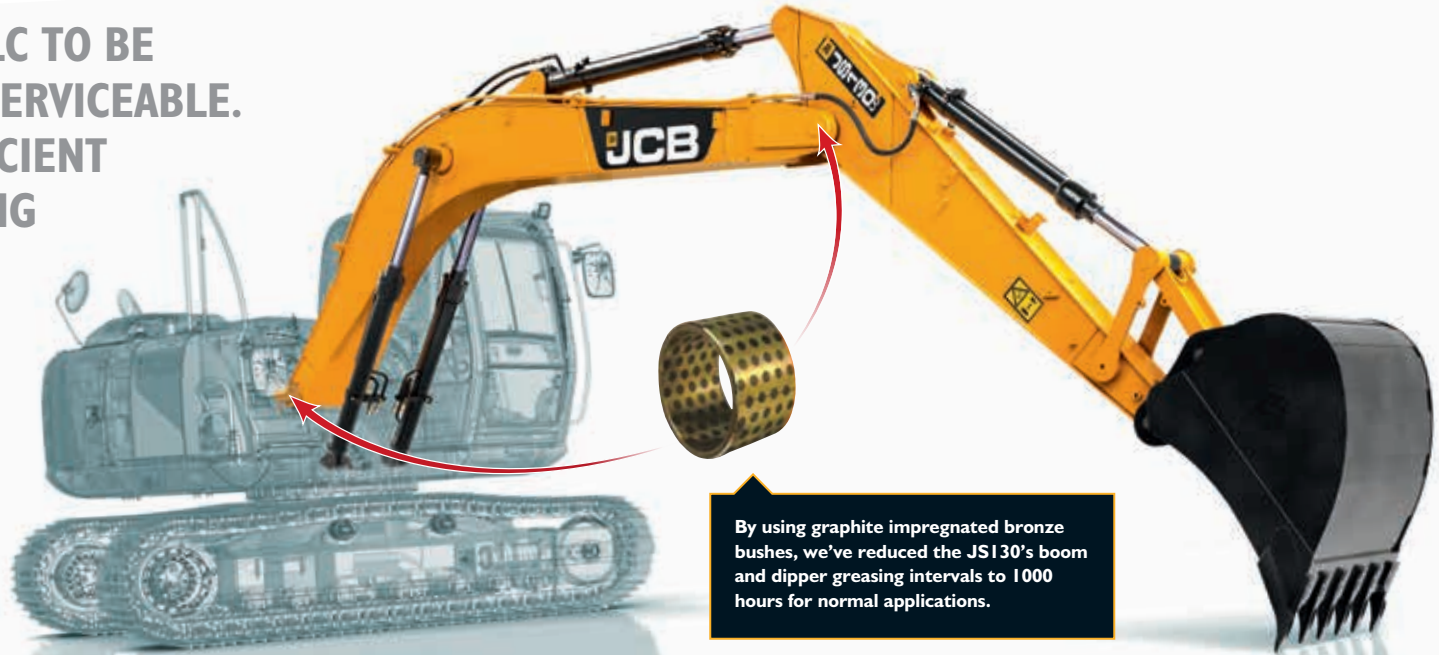

Easy does it

1 The air filter on a JSI30 is easily accessible, and a double-element construction simplifies cleaning.

2 JCB's Plexus Oil Filter System extends oil life to 5000hrs by constantly filtering hydraulic fluid down to 2 microns, reducing risk of contamination.

The filters on a JSI30 (engine oil, hydraulic oil and fuel) are centrally located for fast, easy servicing.

3 Because they're mounted side by side on a JCB JSI30, the engine radiator, hydraulic cooler and intercooler can be serviced individually yet cleaned easily.

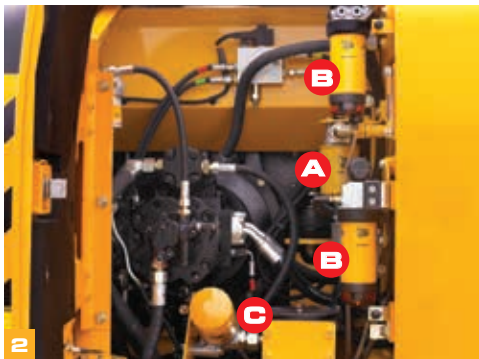

(A) Hydraulics oil filters (B) Fuel filters (C) JCB Plexus Oil Filter System

SERVICE INTERVALS	
Engine oil and oil filter	Every 500 hours
Hydraulic oil	Every 5000 hours
Hydraulic oil filter	Every 1000 hours



UNEARTHED: KEY FACT
 JCB JS130 grease points are centralised for safe and easy access to high level pivots.

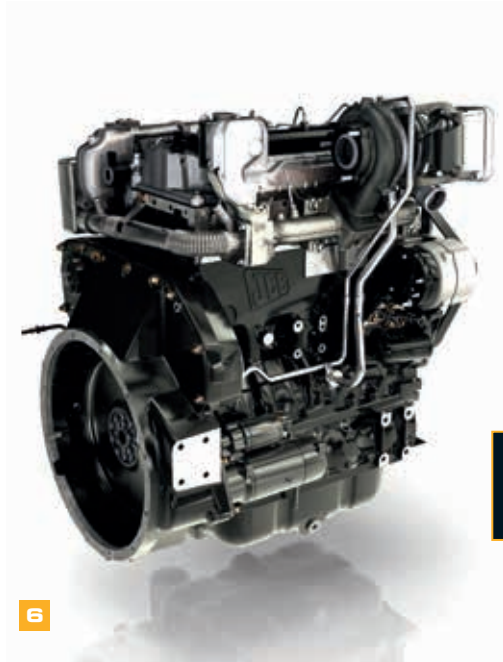

6

Here to help

6 Because the EcoMAX engine doesn't need exhaust after treatment, it doesn't require costly heat-resistant lube oils.

Unlike most Tier 4i engines, JCB EcoMAX doesn't use a Diesel Particulate Filter (DPF) or SCR, saving you additional running costs.

7 We've eliminated the need for a visibowl style pre-cleaner on the JS130 with our new scavenger filtration system. This uses suction from the cooling fan to remove heavier particles from the induction system.

8 Our innovative recalibration option allows EcoMAX to run on lower grade fuels. This means the JS130 can be resold across different territories, which improves residuals.

9 JCB's In-Cab Monitor checks engine oil levels, coolant, and system errors on start-up.



7

JCB JS130 bonnets open and close easily with gas-assisted cylinders, and the service bays are large and wide for good access.



8



9

the safe choice



Safety first

Front-to-rear bonnet opening

ROPS/FOPS protection*

Full hydraulic isolation "2GO"

Great visibility

Anti-slip steps and platform

Cameras*

Full mirror set

Engine/hydraulic heat shield

Safety rails*

LED work lights*

Beacons*

**Optional*

ON-SITE SAFETY IS CRUCIAL, SO WE'VE DESIGNED THE JCB JSI30LC TO INCORPORATE AS MANY CUTTING EDGE SAFEGUARDS AS POSSIBLE. IN SHORT, YOUR OPERATORS ARE IN SAFE HANDS.

We've fitted as standard a bulk head heat shield between the pumps and the engine to guard against heat and noise.



1 The JSI30 bonnet opens front-to-rear for easy and safe engine service access.

2 For extra peace of mind, JCB JSI30 cabs are available with an integral Rollover Protection Structure (ROPS). It's also easy to fit JCB's Falling Objects Protection Structure (FOPS), thanks to standard fitment mounting brackets.

3 JCB's Safety Level Lock fully isolates hydraulic functions to avoid unintended movements. Our 2GO system means a JCB JSI30 can only be started in a safe locked position via two separate inputs.

4 JCB JSI30s have a large glass area and low bonnet line for superb visibility.

5 A JCB JSI30's steps and platforms have anti-slip punched steel plates for optimum grip, even in wet or icy conditions. Bolt-on plates have recessed bolts to reduce trip hazards.

6 Our optional rear and side view cameras display uninterrupted rearwards and sideways views on the smart controller display.

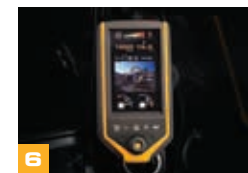

7 Your JS130 is equipped with a full set of side and rear view mirrors for all round visibility and safety compliance.

8 JCB's 2GO system fully isolates hydraulic functions to avoid unintended movements.

9 There's no need to climb onto the JS130 to check oil levels; all routine servicing can be done from ground level.

10 Optional safety rails protect operators from falls when they're on the upper structure of the JS130.

11 The JS130's optional beacons can improve on-site safety still further.

12 Choose LED work lights for an even better field of vision on the JS130.



12



8



9



10

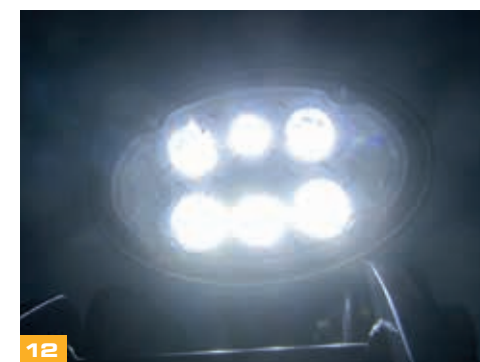

12

LIVELINK, WORK SMARTER

LIVELINK IS AN INNOVATIVE SOFTWARE SYSTEM THAT LETS YOU MANAGE JCB MACHINES REMOTELY – ONLINE, BY EMAIL OR BY MOBILE PHONE. ACCESS EVERYTHING FROM MACHINE ALERTS TO FUEL REPORTS AND HISTORY INFORMATION, WITH ALL DATA STORED AT A SECURE CENTRE.

Productivity and cost benefits

By providing information like idle time monitoring and machine fuel consumption, JCB Livelink helps reduce your fuel usage, saving money and improving productivity. Machine location information can help improve efficiency and perhaps even reduce insurance costs.



Maintenance benefits

Manage machine maintenance easily – accurate hours monitoring and service alerts improve maintenance planning, while real-time location data helps you manage your fleet. Critical machine alerts and maintenance history records are also available.



Security benefits

Livelink's real-time geofencing alerts tell you when machines move out of predetermined zones, and real-time curfew alerts inform you of unauthorised usage. Further benefits include real-time location information, advanced ECU matching (pairs Livelink with the immobiliser or ECU), and PIN code management (to remotely authorise usage – perfect for plant hire).



VALUE ADDED

JCB'S WORLDWIDE CUSTOMER SUPPORT IS FIRST CLASS. WHATEVER YOU NEED AND WHEREVER YOU ARE, WE'LL BE AVAILABLE QUICKLY AND EFFICIENTLY TO HELP MAKE SURE YOUR MACHINERY IS PERFORMING TO ITS FULL POTENTIAL.



1

1 Our Technical Support Service provides instant access to factory expertise, day or night, while our Finance and Insurance teams are always on hand to provide fast, flexible, competitive quotes.

2 The global network of JCB Parts Centres is another model of efficiency; with 15 regional bases, we can deliver around 95% of all parts anywhere in the world within 24 hours. Our genuine JCB parts are designed to work in perfect harmony with your machine for optimum performance and productivity.



2

3 JCB Assetcare offers comprehensive extended warranties and service agreements, as well as service-only or repair and maintenance contracts. Irrespective of what you opt for, our maintenance teams around the world charge competitive labour rates, and offer non-obligation quotations as well as fast, efficient insurance repair work.



3

Note: JCB LIVELINK and JCB ASSETCARE may not be available in your region, so please check with your local dealer.

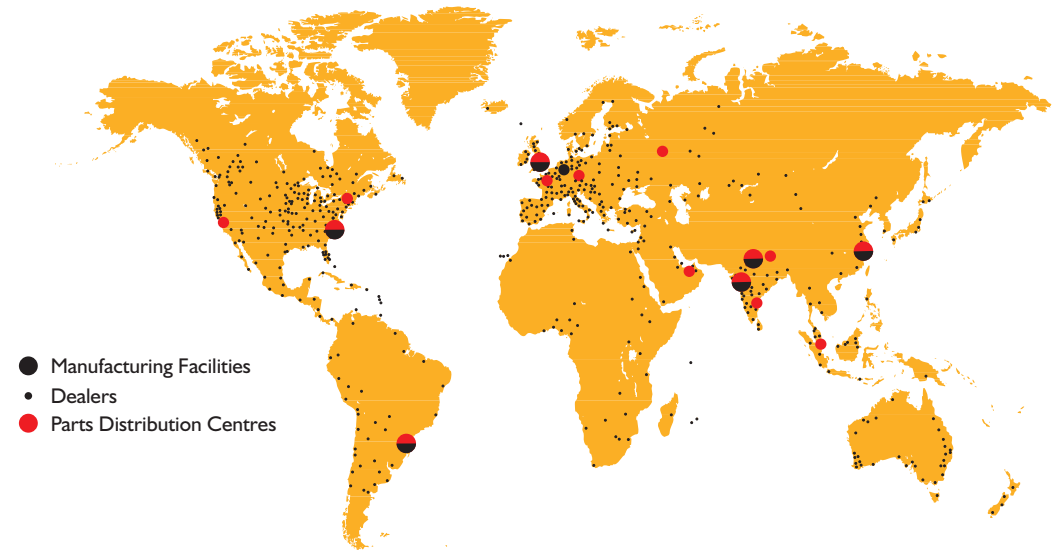

STATIC DIMENSIONS

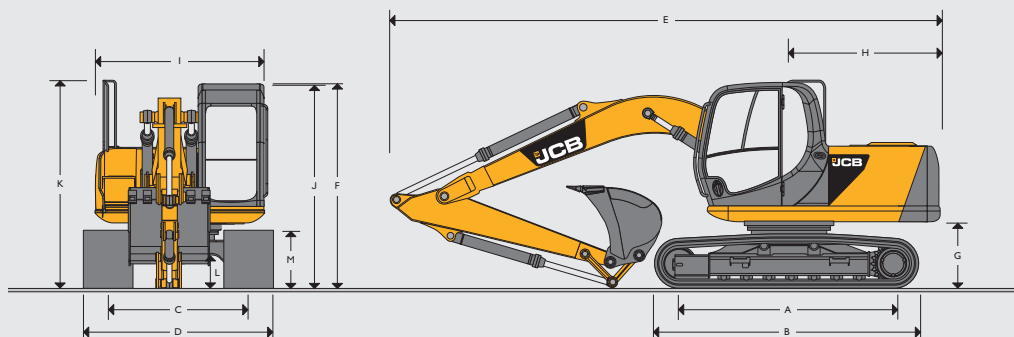

A	Track length on ground	mm	2865
B	Undercarriage overall length	mm	3605
C	Track gauge	mm	1990
D	Width over tracks (500mm trackshoes)	mm	2490
D	Width over tracks (600mm trackshoes)	mm	2590
D	Width over tracks (700mm trackshoes)	mm	2690
D	Width over tracks (850mm trackshoes)	mm	2840
Dipper lengths			
		2.5m	3.0m*
E	Transport length with Monoboom	mm	7620
F	*Transport height with Monoboom	mm	3289
G	*Counterweight clearance	mm	905
H	Tail swing radius	mm	2200
I	Width of superstructure	mm	2410
J	*Height over cab	mm	2845
K	*Height over grab rail	mm	2867
L	*Ground clearance	mm	425
M	Track height	mm	811

*Machine in transport position * Height with upperstructure safety rails: 2967mm.

ENGINE

Model	JCB EcoMAX 444 TCA 81 EU Stage IIIB, EPA Tier 4 interim compliant.
Type	Water cooled, 4-stroke, 4-cylinder in-line, common rail direct injection, turbocharged variable geometry intercooled diesel.
Rated power (ISO 14899 (SAE J1995))	81kW (109hp) at 2050rpm.
Piston Displacement	4.399 litres
Injection	13.8
Air Filtration	Dry
Cooling	Large capacity radiator.
Starting system	24 volt – 4kW.
Batteries	2 x 12 volt.
Alternator	24 volt 55 amp.
Refuelling pump	Electric type (optional).

SWING SYSTEM

Swing motor	Axial piston type.
Swing brake	Hydraulic braking plus automatic spring applied disc type parking brake.
Final drive	Planetary reduction.
Swing speed	12.8 rpm.
Swing gear	Large diameter, internally toothed fully sealed grease bath lubricated.
Swing lock	Multi position switchable brake.

UNDERCARRIAGE

	Fully welded, "X" frame type with central bellyguarding and sloping sidemembers with dirt relief holes under top rollers.
Recovery point	Front and rear.
Upper & lower rollers	Heat treated, sealed and lubricated.
Track adjustment	Grease cylinder type.
Track type	Sealed and lubricated.
Track idler	Sealed and lubricated, with spring cushioned recoil.
Track shoes	500mm triple grouser.
	600mm triple grouser.
	700mm triple grouser.
	850mm triple grouser.
Rollers and Shoes (each side)	Upper rollers: 2
	Lower rollers: 7
	Track shoes: 44

TRACK DRIVE	
Type	Fully hydrostatic, three speed with autoshift between high and medium speed.
Travel motors	Variable swash axial piston type, fully guarded within undercarriage frame.
Final drive	Planetary reduction, bolt-on sprockets.
Service brake	Hydraulic counter balance valve to prevent overspeeding on gradients.
Park brake	Disc type, spring applied, automatic hydraulic release.
Gradeability	70% (35 deg) continuous.
Travel speed	High – 5.2 km/h Mid – 3.1 km/h Low – 2.6 km/h
Tractive effort	128kN

HYDRAULIC SYSTEM	
Pumps	
Main pumps	2 variable displacement axial piston type.
Maximum flow	2 x 134 L/min
Servo pump	Gear type.
Maximum flow	21 L/min
Control valve	
A combined four and five spool control valve with auxiliary service spool as standard.	
Relief valve settings	
Boom/Arm/Bucket	318 bar
With power boost	343 bar
Swing circuit	279 bar
Travel circuit	343 bar
Pilot control	40 bar
Filtration	
In tank	150 micron, suction strainer.
Main return line	10 micron, fibreform element.
Plexus Bypass line	1.5 micron, paper element.
Pilot line	10 micron, paper element.
Hydraulic hammer return	10 micron, reinforced microform element.

SERVICE CAPACITIES	
Machine model	Litres
Fuel tank	253
Engine coolant	19.7
Engine oil	20.4
Swing reduction gear	2.2
Track reduction gear (each side)	3.5
Hydraulic system	124.0
Hydraulic tank	73.0

WEIGHTS AND GROUND BEARING PRESSURES		
Machine equipped with 4.7m Monoboom, 2.5m Dipper, Standard Excavating Bucket, operator and full fuel tank.		
Shoe Width	Operating Weight	Bearing Pressure
500mm	13183kg	0.42kg/sq. cm.
600mm	13373kg	0.36kg/sq. cm.
700mm	13564kg	0.31 kg/sq. cm.
850mm	13762kg	0.27kg/sq. cm.

BUCKET AND ARM COMBINATION									
Arm length	No Q/Hitch Fitted				Q/Hitch Fitted*				Bucket weight
	2.1m	2.5m	2.7m	3.0m	2.1m	2.5m	2.7m	3.0m	
GP bucket 610mm. 0.34m³	☐	☐	☐	☐	☐	☐	☐	☐	368kg
GP bucket 762mm. 0.46m³	☐	☐	☐	☐	☐	■	■	●	460kg
GP bucket 914mm. 0.59m³	☐	☐	■	●	●	●	✘	✘	511kg
GP bucket 1067mm. 0.718m³	☐	■	■	✘	●	✘	✘	✘	579kg
GP bucket 1219mm. 0.85m³	■	■	●	✘	✘	✘	✘	✘	625kg

- ☐ = Suitable for general excavating (materials up to 2000kg/cu.m).
 - = Suitable for light excavating (materials up to 1600kg/cu.m).
 - = Suitable for grading & loading materials up to 1200kg/cu.m).
 - ✘ = Not recommended
- * Bucket capacity using JCB quickhitch only (quickhitch = 186kg).

OPTIONAL BLADE

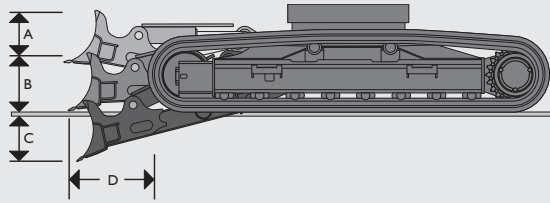





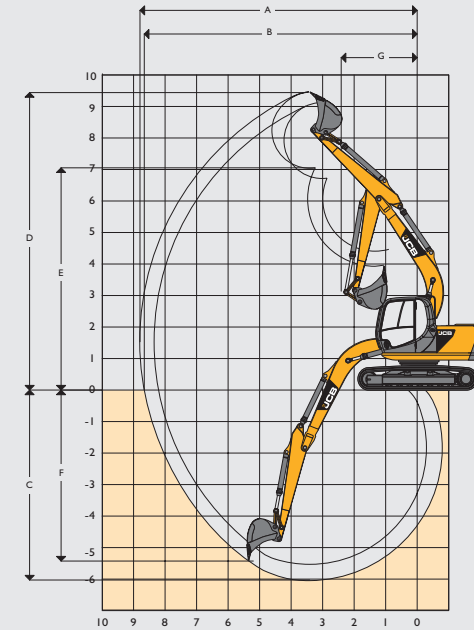





A	Blade height	mm	490
B	Blade lift above ground	mm	440
C	Blade cut below ground	mm	510
D	Blade forward of track	mm	440
	Dozer width – 500mm tracks	mm	2510
	Dozer width – 600mm tracks	mm	2610
	Dozer width – 700mm tracks	mm	2710
Additional machine weight with blade			
	500mm tracks	kg	747
	600mm tracks	kg	753
	700mm tracks	kg	759

WORKING RANGE









Boom length:		4.70m
Dipper length:		2.50m
A	Maximum digging reach	mm 8340
B	Maximum digging reach (on ground)	mm 8197
C	Maximum digging depth	mm 5530
D	Maximum digging height	mm 9118
E	Maximum dumping height	mm 6729
F	Maximum vertical wall cut depth	mm 3625
G	Minimum swing radius	mm 2231
	Bucket rotation	182°
	Maximum dipper tearout (ISO 6015)	kgf 6680
	Maximum bucket tearout (ISO 6015)	kgf 9375
Dipper length:		3.00m
A	Maximum digging reach	mm 8796
B	Maximum digging reach (on ground)	mm 8660
C	Maximum digging depth	mm 6028
D	Maximum digging height	mm 9440
E	Maximum dumping height	mm 7041
F	Maximum vertical wall cut depth	mm 4050
G	Minimum swing radius	mm 2591
	Bucket rotation	182°
	Maximum dipper tearout (ISO 5016)	kgf 5970
	Maximum bucket tearout (ISO 5016)	kgf 9375











LIFT CAPACITIES – Dipper length: 2.50m, 4.70m Monoboomb, Trackshoes: 500mm, No bucket. JSI30 LC MONO

Reach	3m		4m		5m		6m		Capacity at Max Reach		
											
Load Point Ht.	kg	kg	kg	kg	kg	kg	kg	kg	kg	mm	
6.0m			2800*	2800*	3010*	3010*			2370*	2370*	5533
5.0m			2980*	2980*	3020*	3020*	3110*	2430	2240*	2240*	6221
4.0m	3860*	3860*	3490*	3490*	3270*	3210	3170*	2410	2190	2010	6689
3.0m	5400*	5400*	4250*	4250*	3680*	3110	3350	2360	2190*	1850	6982
2.0m	7130*	6310	5100*	4120	4150*	2990	2380	2290	2250*	1770	7121
1.0m	6370*	5990	5810*	3940	4200	2880	3210	2580	2360	1740	7116
0m	6830*	5860	5780	3820	4120	2810	3160	2180	2540*	1780	6967
- 1.0m	8630*	5820	5720	3770	4070	2760	3130	2160	2710	1880	6663
- 2.0m	8240*	5850	5720	3770	4060	2760	4140	2170	3020	2090	6181
- 3.0m	7460*	5930	5370*	3810	4100	2790			3620	2490	5474

LIFT CAPACITIES – Dipper length: 2.70m, 4.70m Monoboomb, Trackshoes: 500mm, No bucket. JSI30 LC MONO

Reach	3m		4m		5m		6m		Capacity at Max Reach		
											
Load Point Ht.	kg	kg	kg	kg	kg	kg	kg	kg	kg	mm	
6.0m					2840*	2840*			2530*	2530*	5653
5.0m			2720*	2720*	2720*	2820*	2950*	2440	2390*	2240	6326
4.0m			3150*	3150*	3040*	3040*	3000*	2380	2330*	1960	6785
3.0m	4660*	4660*	3830*	3830*	3410*	2970	3190*	2290	2320*	1800	7075
2.0m	6270*	5680	4620*	3820	3850*	2830	3150	2210	2380*	1710	7210
1.0m	7520*	5440	5330*	3640	3940	2710	3070	2130	2400	1670	7205
0m	8090*	5340	5290	3520	3840	2630	3000	2070	2430	1690	7060
- 1.0m	8130*	5290	5230	3470	3790	2580	2970	2040	2560	1770	6759
- 2.0m	7800*	5270	5210	3450	3770	2560	2970	2040	2810	1940	6287
- 3.0m	7110*	5280	5240	3480	3810	2590			3300	2270	5592





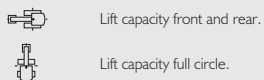



LIFT CAPACITIES – Dipper length: 3.00m, 4.70m Monoboomb, Trackshoes: 500mm, No bucket. JSI30 LC MONO

Reach	3m		4m		5m		6m		Capacity at Max Reach		
											
Load Point Ht.	kg	kg	kg	kg	kg	kg	kg	kg	kg	mm	
6.0m					2540*	2540*	2520*	2460	2180*	2180*	6113
5.0m					2610*	2610*	2720*	2470	2070*	2010*	6741
4.0m			2960*	2960*	2890*	2890*	2840*	2430	2030*	1790	7175
3.0m	4460*	4460*	3710*	3710*	3310*	3140	3080*	2370	2040*	1660	7448
2.0m	6210*	6210*	4600*	4180	3820*	3010	3280	2290	2090*	1590	7578
1.0m	7640*	6060	5410*	3960	4210	2880	3200	2220	2190*	1570	7574
0m	7510*	5830	5770	3810	4100	2780	3140	2160	2300	1590	7434
- 1.0m	8610*	5740	5670	3720	4030	2720	3090	2120	2420	1670	7150
- 2.0m	8430*	5730	5640	3690	4000	2700	3080	2100	2650	1820	6704
- 3.0m	7880*	5780	5660	3710	4020	2710	3110	2130	3070*	2110	6060











- Notes:**
1. For lifting capacity including bucket, subtract total weight of bucket or bucket and quickhitch from above values.
 2. Lifting capacities are based on ISO 10567, that is: 75% of minimum tipping load or 87% of hydraulic lift capacity, whichever is the less. Lifting capacities marked* are based on hydraulic capacity.
 3. Lift capacities assume that the machine is on firm, level ground.
 4. Lift capacities may be limited by local regulations. Please refer to your dealer.











LIFT CAPACITIES – Dipper length: 2.50m, 4.70m Monoboomb, Trackshoes: 500mm, No bucket, Dozer. JS130 LC MONO

Reach	3m		4m		5m		6m		Capacity at Max Reach		mm
											
Load Point Ht.	kg	kg	kg	kg	kg	kg	kg	kg	kg	kg	
6.0m			2800*	2800*	3010*	3010*			2370*	2370*	5533
5.0m			2980*	2980*	3020*	3020*	3110*	2540	2240*	2240*	6221
4.0m	3860*	3860*	3490*	3490*	3270*	3270*	3170*	2520	2190*	2110	6689
3.0m	5400*	5400*	4250*	4250*	3680*	3250	3370*	2470	2190*	1940	6982
2.0m	7130*	6600	5100*	4310	4150*	3130	3560	2410	2250*	1860	7121
1.0m	6370*	6280	5810*	4130	4570	3030	3500	2350	2360*	1840	7116
0m	6830*	6140	6260	4010	4480	2950	3440	2300	2540*	1870	6967
- 1.0m	8630*	6110	6240	3960	4440	2900	3420	2270	2840*	1980	6663
- 2.0m	8240*	6140	6240	3960	4430	2900	3420	2280	3290	2200	6181
- 3.0m	7460*	6210	5370*	4000	4460*	2940			3850*	2620	5474

LIFT CAPACITIES – Dipper length: 2.70m, 4.70m Monoboomb, Trackshoes: 500mm, No bucket, Dozer. JS130 LC MONO

Reach	3m		4m		5m		6m		Capacity at Max Reach		mm
											
Load Point Ht.	kg	kg	kg	kg	kg	kg	kg	kg	kg	kg	
6.0m					2840*	2840*			2530*	2530*	5653
5.0m			2720*	2720*	2820*	2820*	2950*	2560	2390*	2350	6326
4.0m			3150*	3150*	3040*	3040*	3000*	2490	2330*	2060	6785
3.0m	4660*	4660*	3830*	3830*	3410*	3110	3190*	2400	2320*	1890	7075
2.0m	6270*	5940	4620*	4000	3850*	2960	3430	2320	2380*	1800	7210
1.0m	7520*	5700	5330*	3810	4270*	2840	3340	2240	2490*	1760	7205
0m	8090*	5600	5770	3700	4190	2760	3270	2180	2650*	1780	7060
- 1.0m	8130*	5550	5710	3460	4130	2710	3240	2150	2790	1860	6759
- 2.0m	7800*	5530	5690	3630	4120	2700	3240	2150	3070	2040	6287
- 3.0m	7110*	5540	5490*	3650	4150	2730			3600	2390	5592

LIFT CAPACITIES – Dipper length: 3.00m, 4.70m Monoboomb, Trackshoes: 500mm, No bucket, Dozer. JS130 LC MONO

Reach	3m		4m		5m		6m		Capacity at Max Reach		mm
											
Load Point Ht.	kg	kg	kg	kg	kg	kg	kg	kg	kg	kg	
6.0m					2540*	2540*	2520*	2520*	2180*	2180*	6113
5.0m					2610*	2610*	2720*	2580	2070*	2070*	6741
4.0m			2960*	2960*	2890*	2890*	2840*	2540	2030	1880	7175
3.0m	4460*	4460*	3710*	3710*	3310*	3280	3080*	2480	2040*	1750	7448
2.0m	6210*	6210*	4600*	4370	3820*	3150	3380*	2410	2090*	1680	7578
1.0m	7640*	6350	5410*	4150	4310*	3020	3490	2330	2190*	1650	7574
0m	7510*	6120	5990*	4000	4470	2930	3420	2270	2350*	1680	7434
- 1.0m	8610*	6030	6200*	3910	4400	2860	3380	2230	2590*	1760	7150
- 2.0m	8430*	6020	6160	3880	4370	2840	3360	2220	2890	1920	6704
- 3.0m	7880*	6070	5970*	3900	4380	2850			3350	2220	6060

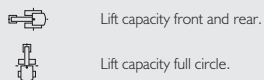

Notes:

1. For lifting capacity including bucket, subtract total weight of bucket or bucket and quickhitch from above values.
2. Lifting capacities are based on ISO 10567, that is: 75% of minimum tipping load or 87% of hydraulic lift capacity, whichever is the less. Lifting capacities marked* are based on hydraulic capacity.
3. Lift capacities assume that the machine is on firm, level ground.
4. Lift capacities may be limited by local regulations. Please refer to your dealer.





Hydraulic Excavator JS130 LC

Engine Power: 81kW (109hp)

Bucket Capacity: 0.34 – 0.85m³

Operating weight: 13,183 – 13,762kg

Your nearest JCB dealer